

DRAFT SPECIFICATION

Part No. : **PC29.09.0100A**

Product Name : TheStripe™
Penta-band Cellular 850/900/1800/1900
UMTS/WCDMA(3G) 2100 MHz PCB Antenna

Feature : 100mm long, 1.13 mm diameter
Miniature Co-axial Cable MMCX(M)RA
Average Efficiency 62%
Tested in Free space
Dims: 80*30mm
RoHS compliant

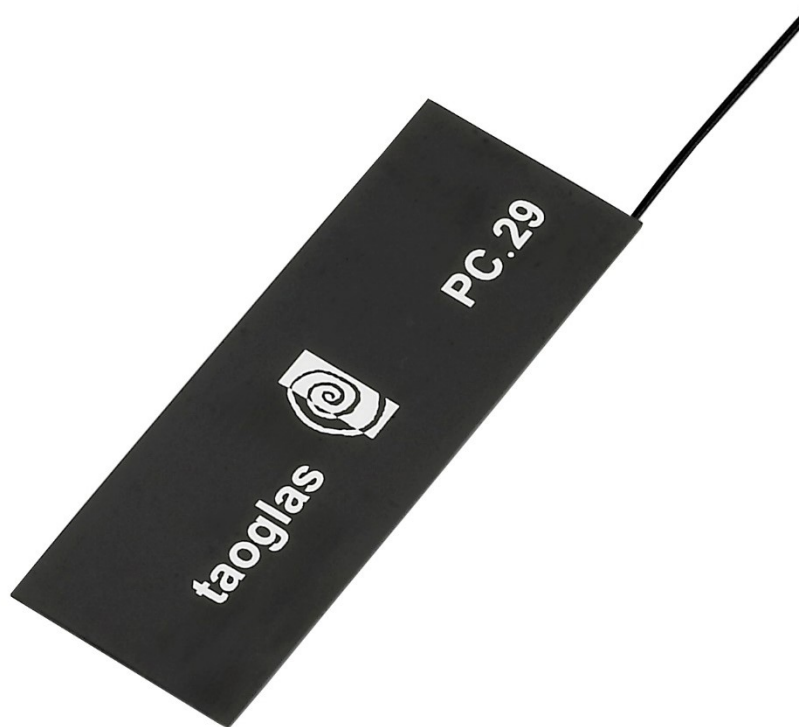

1. Introduction

This high performance, low profile, PCB antenna is based on smart TheStripe™ antenna technology. It consists of a PCB antenna and mini coaxial cable. The product is a high gain Penta-band 850/900/1800/1900/2100 antenna suitable for worldwide GSM, UMTS and WCDMA applications. Its high efficiency (62% average) makes it an ideal choice to pass telecom operator’s testing approvals. The product should be tested in free space conditions connected to the client’s cellular device.

Further optimization can be done upon receipt of the client’s device at a local Taoglas facility.

2. Key antenna Performance Indicators

Cellular					
Communication system	AMPS	GSM	DCS	PCS	UMTS/WCDMA
Frequency Band	850MHz	900MHz	1800MHz	1900MHz	2100MHz
VSWR	1.58	1.78	1.51	1.38	1.37
Return Loss	-12.96	-11.00	-13.79	-15.81	-16.11
Efficiency	56.84%	72.98%	63.52%	55.79%	63.25%
Peak Gain	0.01dBi	1.2dBi	2.66dBi	1.25dBi	1.43dBi
Average Gain	-2.45dB	- 1.37dB	- 1.97dB	-2.53dB	-1.99dB
Impedance	50 Ohm				
Radiation Pattern	Omnidirectional				
Polarization	Horizontal				

3. Mechanical Specifications

3.1 Dimensions and Drawing

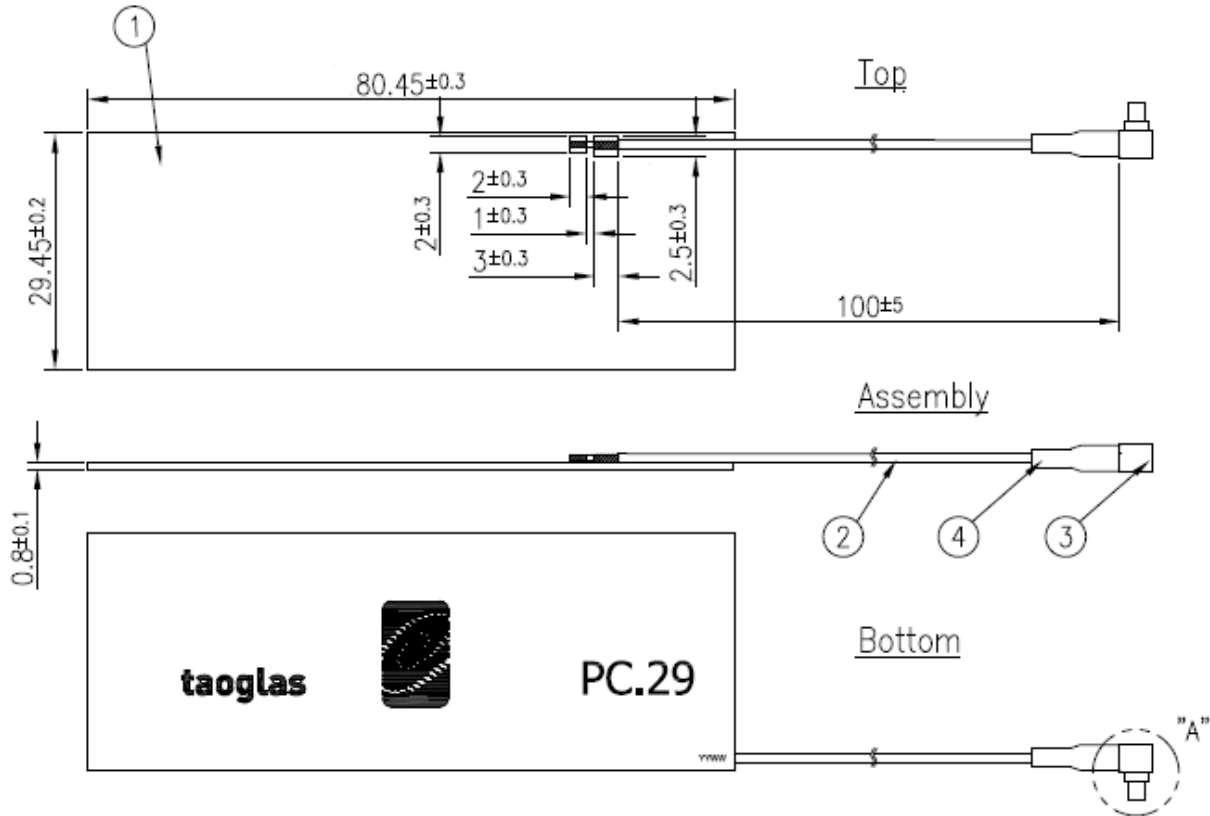

3.2 Cable and Connector

RF Cable	RF Coaxial Cable $\varphi 1.13 \pm 0.1\text{mm}$, L = 100 mm Gray Colour
RF Connector	MMCX(M)RA

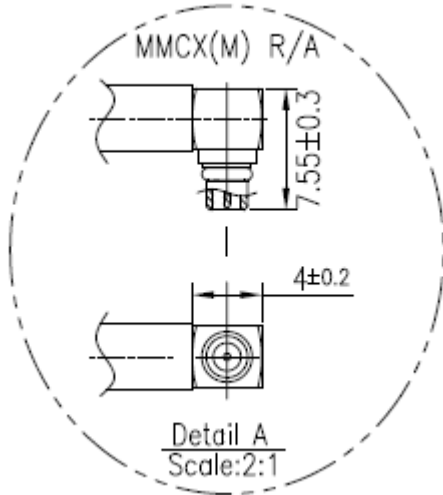

NOTES:

1. No dregs or insufficient soldering. Solder thickness 0.3 ~1.7mm
2. The solder must be smooth and full to the edges of the pad.
The solder must not extend outside of the pad area.
3. The connector position has special orientation to the PCB as per drawing.
4. All material must be RoHS compliant.
5. Open/short QC, VSWR required.
6. Soldered area. 

	Name	P/N	Material	Finish	QTY
1	PC29 PCB	100211C050005A	FR4 0.8t	Black	1
2	1.13 Mini-Coaxial Cable	300215C020000A	FEP	Black	1
3	MMCX(M) R/A	202812B000013A	Brass	Au Plated	1
4	Heat Shrink Tube	001315C000000A	PE	Black	1

3.3 Antenna Placement

Antenna designed to for testing when connected outside the client’s device and placed in frees pace conditions, for example on plastic foam block. Final product can use pre-applied double sided adhesive tape, slot or screw mount.

4. Antenna Electrical Characteristics

4.1 Return loss

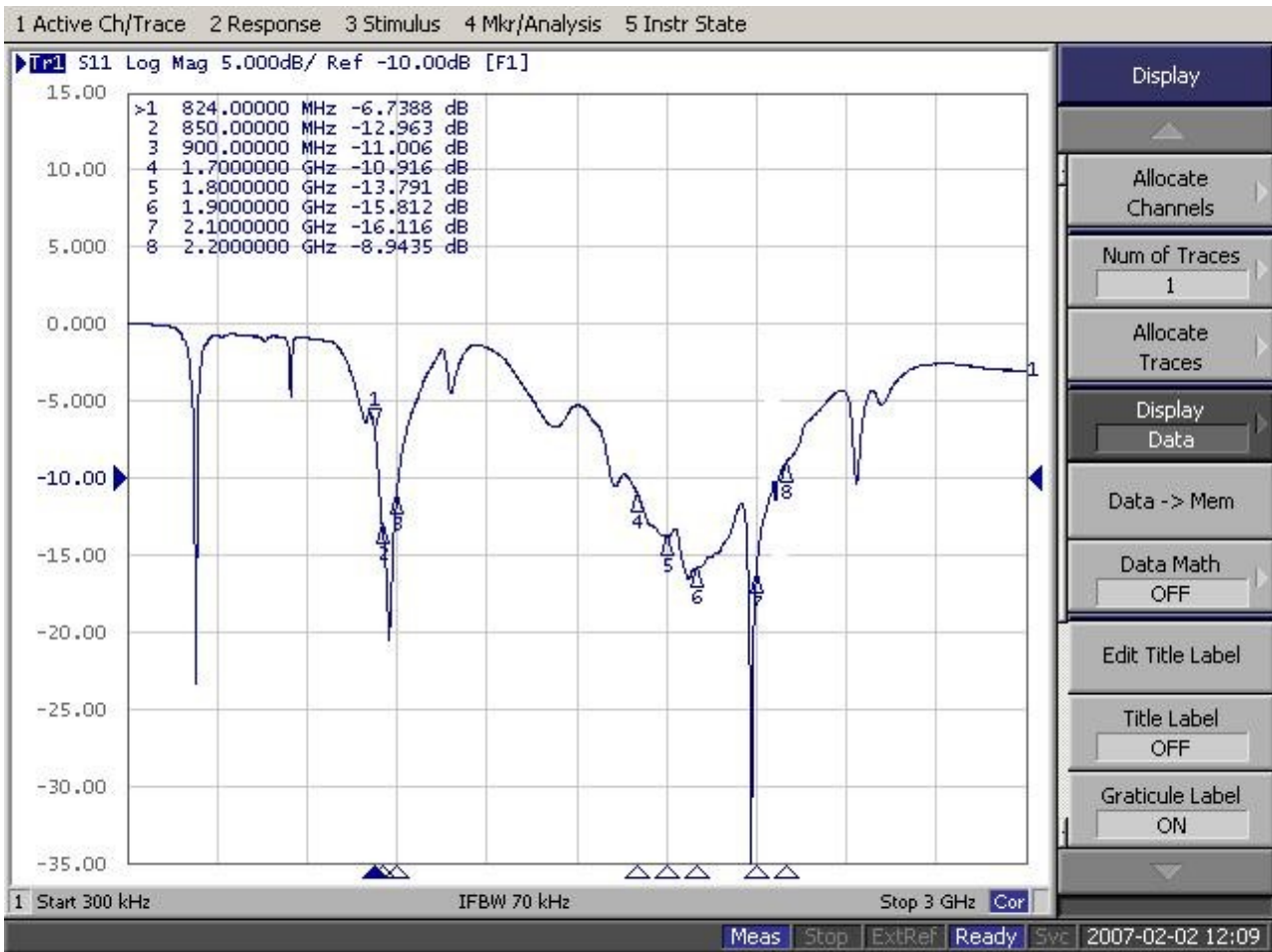

5. Environmental Conditions and Reliability

5.1 Environmental Conditions

Operation Temperature	-40°C to + 85°C
Storage Temperature	-40°C to + 95°C
Relative Humidity	40% to 95%

5.2 Reliability

Test Items	Procedure	Requirement
Thermal Shock	Starting at -40 for 30minutes and then cycled to +85 to remain 30minutes (a complete cycle). To repeat 5 complete cycles. (Refer to IEC 68-2-14 Method Na)	<ol style="list-style-type: none"> 1. The value of return loss must be within product specifications after this test. 2. No physical deformation should be evident.
Storage Temperature (Cold)	Samples must be put into -30°C chamber for 72 hours and samples shall be powered during test. (Refer to IEC 68-2-1 Method Aa)	<ol style="list-style-type: none"> 1. The value of return loss must be within product specifications after this test. 2. No physical deformation should be evident.
Storage Temperature (Dry Heat)	Samples must be put into +75°C chamber for 72 hours and samples shall be powered during test. (Refer to IEC 68-2-1 Method Ba)	<ol style="list-style-type: none"> 1. The value of return loss must be within product specifications after this test. 2. No physical deformation should be evident.
Operating Temperature (Cold)	Samples must be put into -20°C chamber for 2 hours and samples shall be powered during test. (Refer to IEC 68-2-1 Method Aa)	<ol style="list-style-type: none"> 1. The value of return loss must met specification during test/after test 2. No mechanical defects after test.
Operating Temperature (Dry Heat)	Samples must be put into +65°C chamber for 72 hours and samples shall be powered during test. (Refer to IEC 68-2-1 Method Ba)	<ol style="list-style-type: none"> 1. The value of return loss must met specification during test/after test 2. No mechanical defects after test.

6. Antenna Test Procedures and Setup

6.1 Test Procedure for VSWR/Return Loss

6.1.1. STEP 1 Route Cable in Correct Position

6.1.2. STEP 2 Connect Antenna to Module

Connect feed-line to network analyze

6.1.3. STEP 3 - Assemble Antenna in Correct Position

6.1.4. STEP 4 - Assemble Housing

6.2 3D Radiation Pattern Testing

6.2.1 Test Setup Diagram

Radiation Pattern Testing - Anechoic Chamber

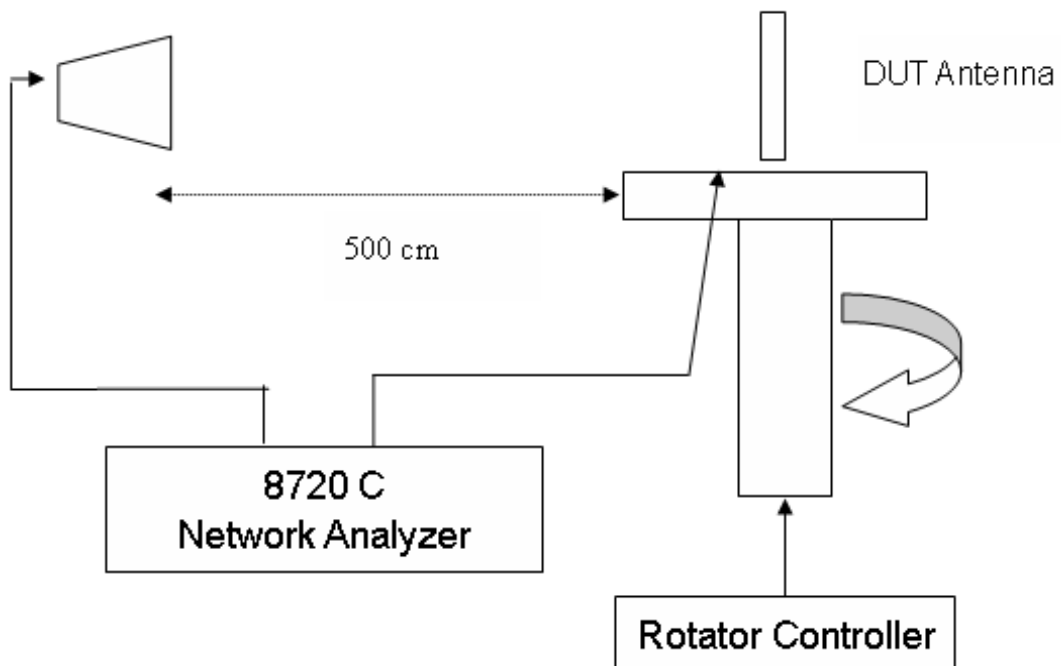

6.3 3D Radiation Pattern Testing

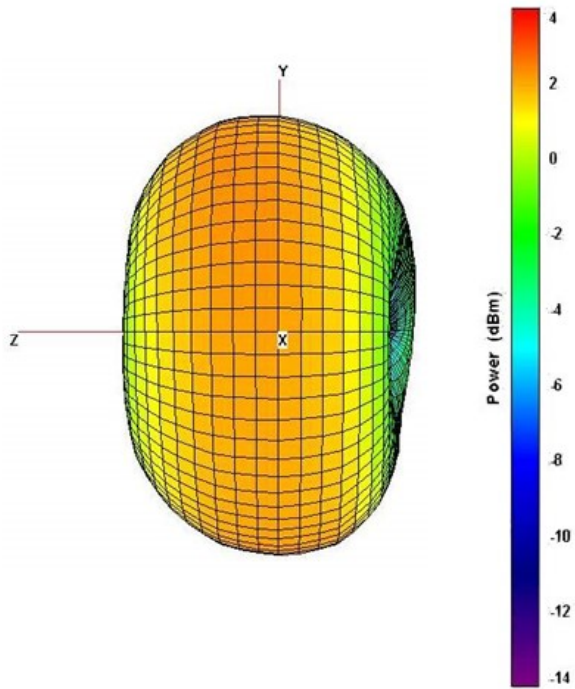
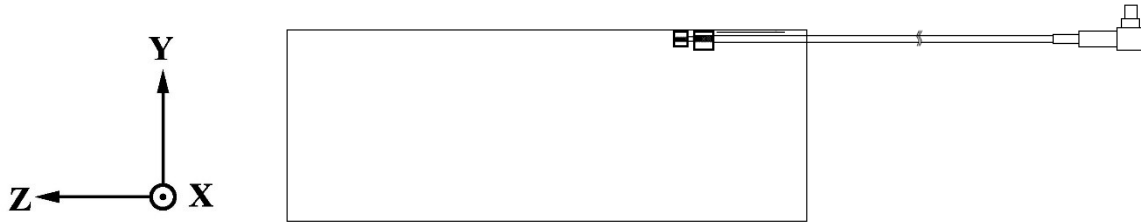

850MHz

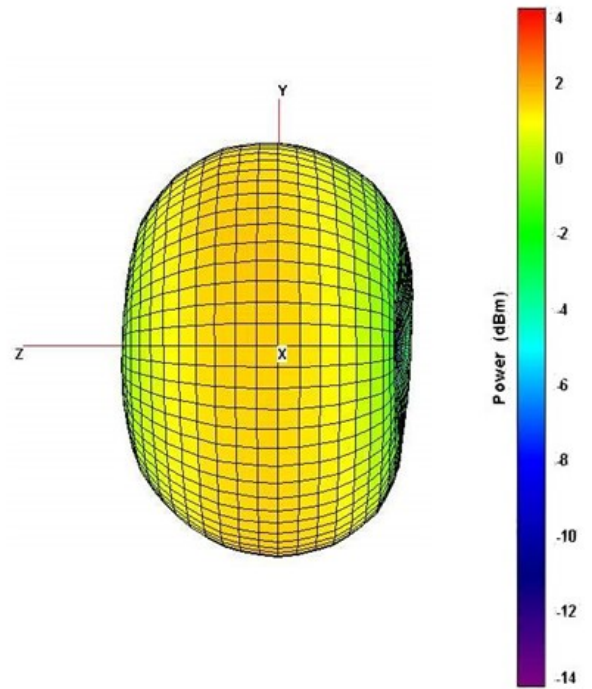

900MHz

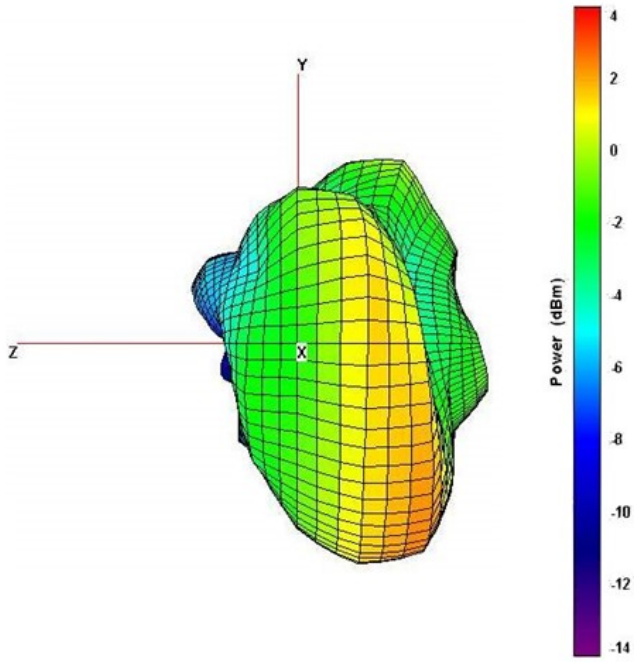

1800MHz

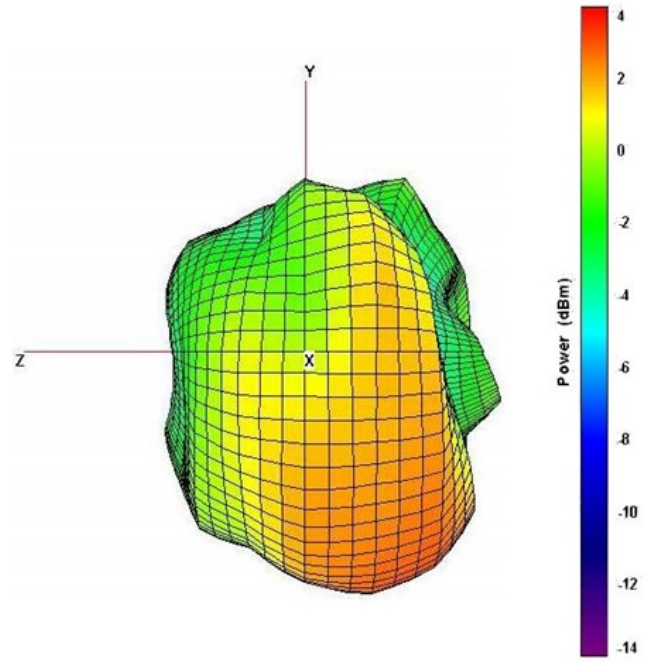

1900 MHz

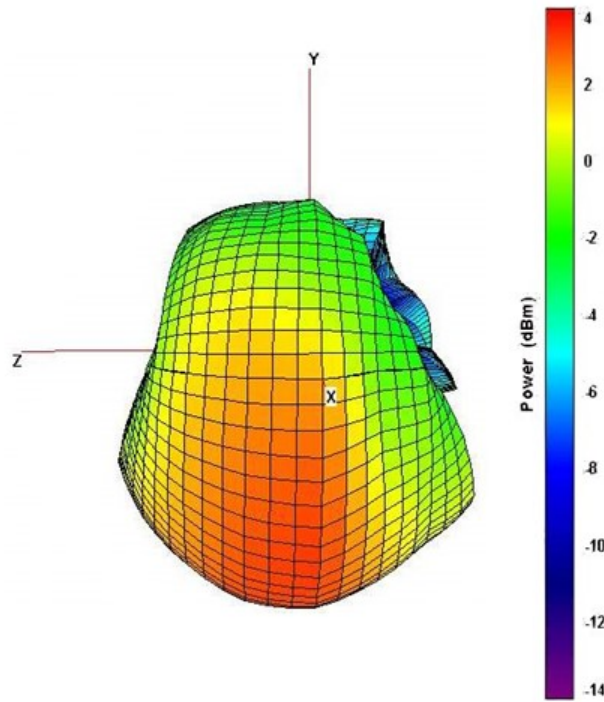

2100MHz

6.4 3D Chamber Testing – Tabular Results

Channel	850	900	1800	1900	2100
Note					
Ant. Port Input Pwr. (dBm)	0	0	0	0	0
Tot. Rad. Pwr. (dBm)	-2.45333	-1.36794	-1.97033	-2.53429	-1.98915
Peak EIRP (dBm)	0.015689	1.20176	2.66193	1.24876	1.43211
Directivity (dBi)	2.46902	2.5697	4.63226	3.78305	3.42126
Efficiency (dB)	-2.45333	-1.36794	-1.97033	-2.53429	-1.98915
Efficiency (%)	56.8417	72.9803	63.5283	55.7919	63.2536
Gain (dBi)	0.015689	1.20176	2.66193	1.24876	1.43211
NHPRP ±Pi/4 (dBm)	-3.02704	-1.92238	-2.97144	-3.45498	-2.82882
NHPRP ±Pi/6 (dBm)	-4.06616	-2.96253	-4.30533	-4.76442	-4.0912
NHPRP ±Pi/8 (dBm)	-5.02906	-3.92452	-5.46289	-5.86661	-5.13854
Upper Hem. PRP (dBm)	-5.26654	-4.1779	-8.15472	-6.78538	-4.25527
Lower Hem. PRP (dBm)	-5.67008	-4.58827	-3.16646	-4.58066	-5.89806
NHPRP4 / TRP Ratio (dB)	-0.57372	-0.55444	-1.00111	-0.92069	-0.83967
NHPRP4 / TRP Ratio (%)	87.6251	88.0149	79.4126	80.8967	82.4201
NHPRP6 / TRP Ratio (dB)	-1.61284	-1.59459	-2.335	-2.23013	-2.10205
NHPRP6 / TRP Ratio (%)	68.9789	69.2693	58.4117	59.8394	61.6304
NHPRP8 / TRP Ratio (dB)	-2.57573	-2.55658	-3.49256	-3.33232	-3.14939
NHPRP8 / TRP Ratio (%)	55.2621	55.5062	44.7449	46.4268	48.424
UHPRP / TRP Ratio (dB)	-2.81321	-2.80996	-6.18439	-4.25109	-2.26612
UHPRP / TRP Ratio (%)	52.3213	52.3605	24.0747	37.5743	59.3455
LHPRP / TRP Ratio (dB)	-3.21676	-3.22033	-1.19613	-2.04636	-3.90891
LHPRP / TRP Ratio (%)	47.6787	47.6395	75.9253	62.4257	40.6545
Front/Back Ratio (dB)	0.845463	1.05517	9.54643	6.84502	5.08847
Phi BW (°)	360	360	178	201	222
+ Phi BW (°)	360	360	88	125	65
- Phi BW (°)	0	0	90	76	157
Theta BW (°)	81	80	46	66	105
+ Th. BW (°)	38	38	19	41	46
- Th. BW (°)	43	42	27	25	59
Boresight Phi (°)	255	255	300	240	315
Boresight Th. (°)	90	90	120	105	90
Maximum Power (dBm)	0.015689	1.20176	2.66193	1.24876	1.43211
Minimum Power (dBm)	-19.5093	-20.8812	-13.7782	-14.9471	-13.4615
Average Power (dBm)	-3.93427	-2.8818	-2.73192	-3.54007	-3.05829
Max/Min Ratio (dB)	19.525	22.083	16.4401	16.1959	14.8936
Max/Avg Ratio (dB)	3.94996	4.08357	5.39385	4.78883	4.4904
Min/Avg Ratio (dB)	-15.575	-17.9994	-11.0462	-11.4071	-10.4032
Average Gain (dB)	-2.45333	-1.36794	-1.97033	-2.53429	-1.98915
E-Plane BW (°)	360	360	168	194	214
+ E-Plane BW (°)	360	360	98	125	158
- E-Plane BW (°)	0	0	70	69	56
H-Plane BW (°)	81	80	48	72	104
+ H-Plane BW (°)	42	41	27	26	48
- H-Plane BW (°)	39	39	21	46	56

7. Packaging (Unit: mm)

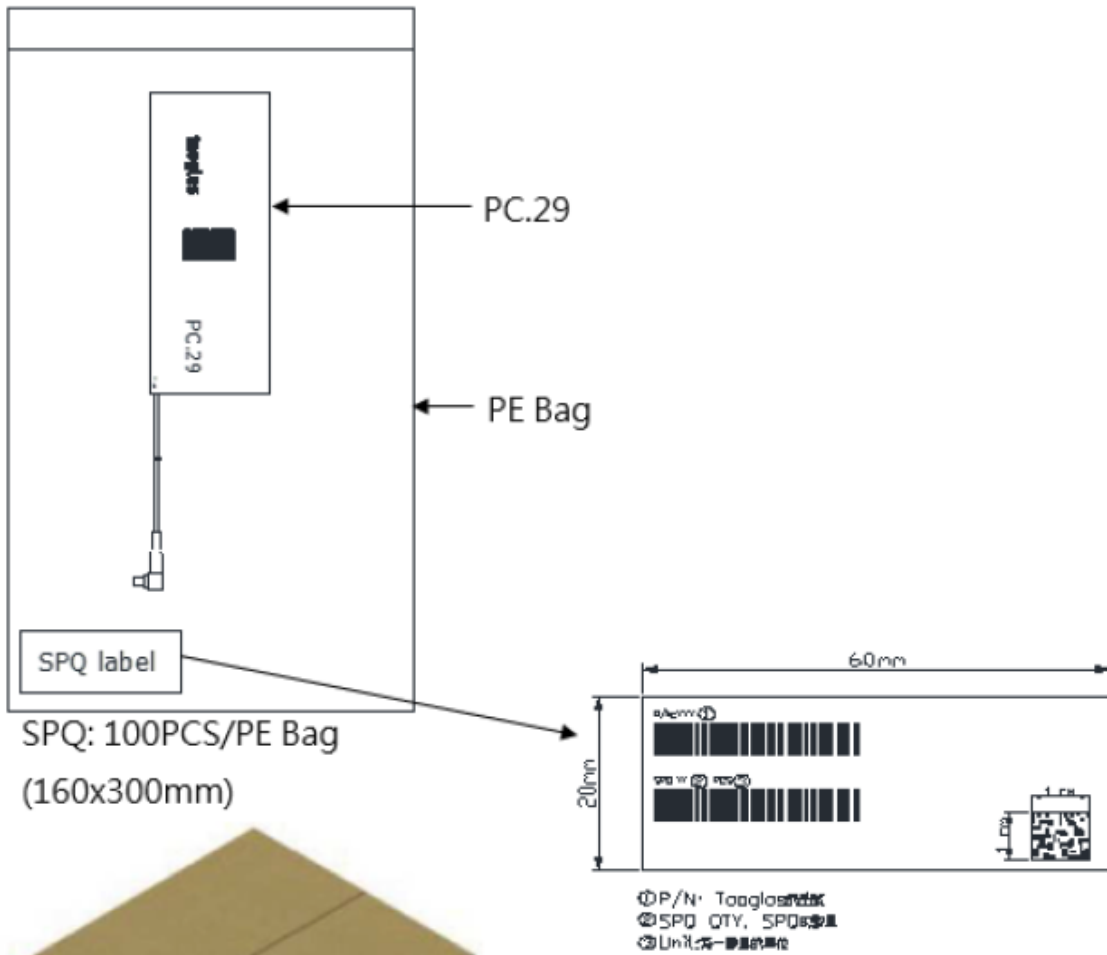

2500PCS/Carton
(320x250x230mm)

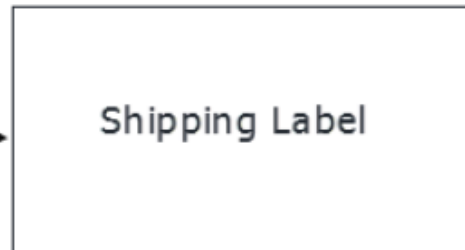

Taoglas makes no warranties based on the accuracy or completeness of the contents of this document and reserves the right to make changes to specifications and product descriptions at any time without notice.

Taoglas reserves the rights to this document and the information contained herein. Reproduction, use or disclosure to third parties without express permission is strictly prohibited.

Copyright © Taoglas Ltd.

